



3000 REVOLUTION





Concept

Design, innovative and robust constructions, effective solutions for all applications and the unique large waste hopper make the Dulevo 3000 Revolution the perfect working tool for all seasons – everywhere and at any time - regardless of high or low temperatures, sun, rain or snow. Up to date technology and top-quality components ensure the high quality demands of the market – a guaranty of longevity.



Comfort

Operators comfort and ergonomics are our priority together with application specifications. Effective axle suspensions and ideal weight distribution insure a balanced and safe drive ability. The powerful drive transmission guarantees the use in difficult conditions and on slopes too.



Cabin

The generous interior space of the cabin and the quality seats make the machine an extremely comfortable workplace. An additional insulation and springs protect the operator from noise emissions and vibrations.

The large window surfaces of the cab allow the all-round view of the working area. The standard equipment includes heated mirrors, air condition and a charging plug for mobile devices.



Access & Service

The innovative, modular structure with the unique tillable cabin and the on-top-centred position of all main components allow the most simple access to all important components for service and maintenance. Dulevo 3000 Revolution is fully hydrostatic driven without the use of any electronic components.



Environment

Dulevo and environmental awareness belongs together since several time. Lowest noise, dust emission, lowest water and fuel consumption are the basic concept of Dulevo 3000 Revolution. With a proofed fine dust reduction of 100% (compared to standard suction sweeping equipment) and a water saving of up to 60%, Dulevo 3000 Revolution fulfils all the environmental future demands. The engine respects the latest EU emission regulations.

Fine dust emissions – System related differences:

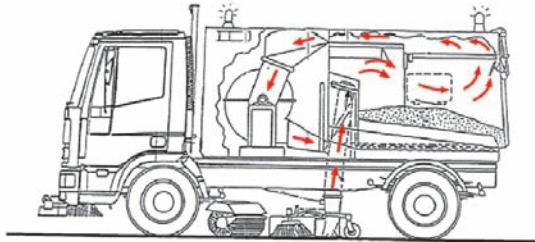

Traditional suction system

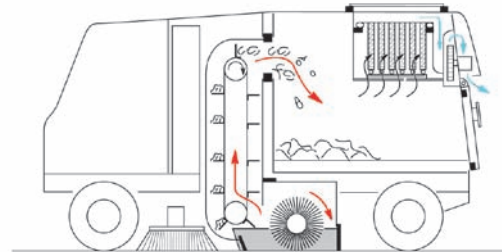

Dulevo Patented Mechanical-suction-filter system

Filter



Dulevo filter



Dulevo International unique filtration technology



In cooperation with Gore® Dulevo developed the only worldwide existing full fine dust filtration sweeper. This mechanical-suction-filtration system grants with the exclusive application of the Gore® technology a total abatement of PM10 particles.

Further benefits of the filter technology are:

- No Maintenance
- Self cleaning effect
- Highest proofed absorbing of PM10 / PM5 / PM2,5 / PM 1
- Granted constant & durable filtering
- 35 % higher Airflow
- Resistance against water, oil, fats, chemical agents, etc

GORE dust filters installed in the industrial sweeper have 5 YEARS warranty.

FILTERING CAPACITY (with Certificate of conformity issued by TÜV and DNV)

		Fraction with granulometry < 1 µm	63%
		Fraction with granulometry < 2,5 µm	90%
		Fraction with granulometry < 5 µm	98%
		Fraction with granulometry < 10 µm	>99%

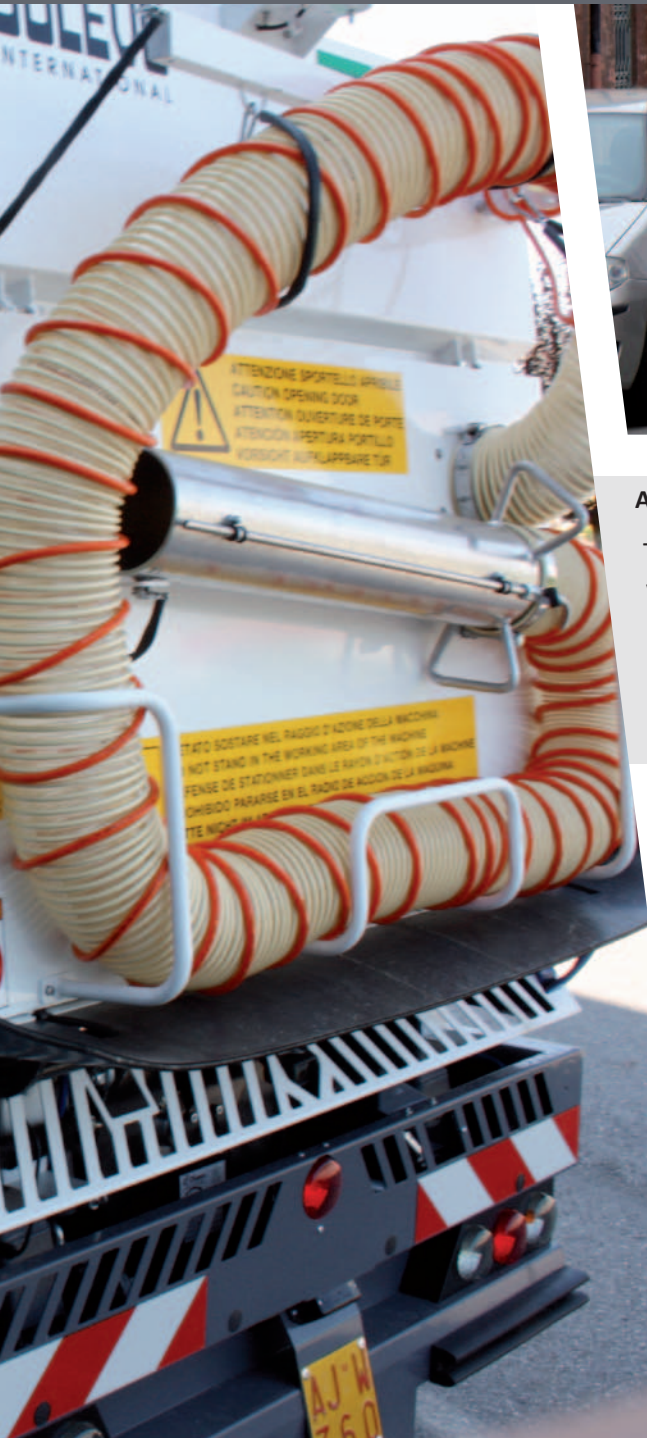

Application

The 180-degree full motion massive front brush is an indispensable auxiliary tool for sweeping corners, gutters and for increasing working width.

The hopper uplifting system allows the discharge of the debris in refuse containers, trucks or in big refuse compactors. A variety of options expand the working spectrum of Dulevo 3000 Revolution – everywhere at any time.

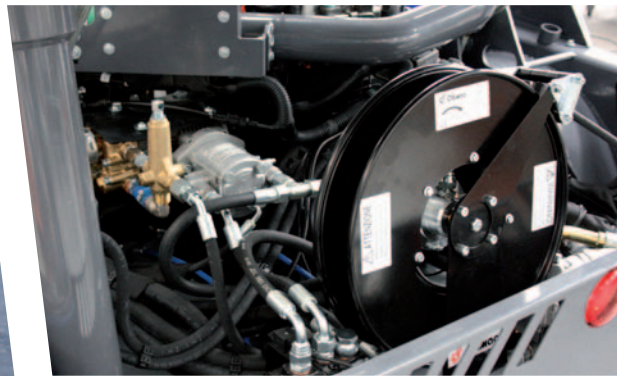

Security

One of Dulevo priority has always been the safety in the working environment of the machine. Dulevo 3000 Revolution is standardized equipped with a reverse camera with a colour screen in the cabin next to an acoustical warning.

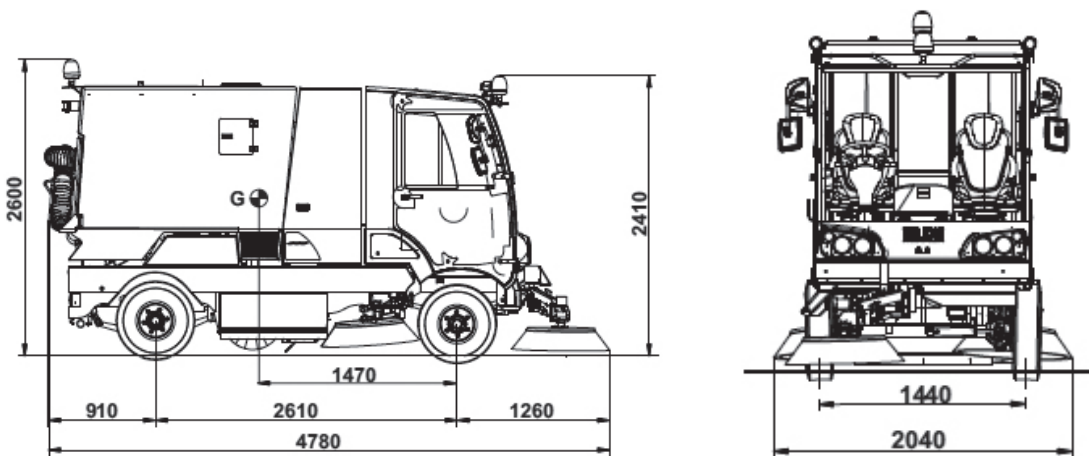
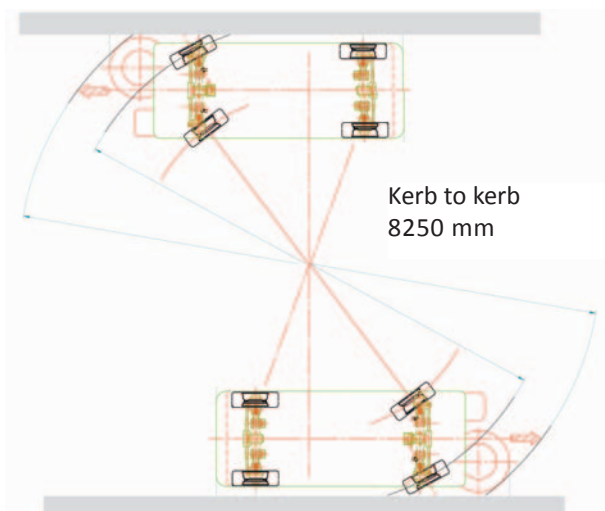
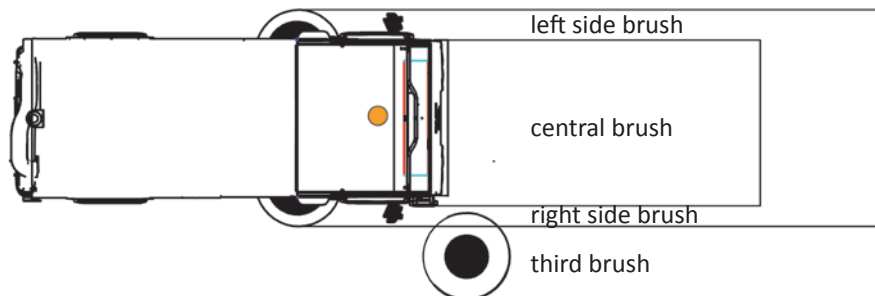

Technical data		3000 Revolution
Sweeping width:		
-with central brush	mm	1300
-with side brushes	mm	2100
-with third brush	mm	2900
Central brush diameter	mm	520
Side brushes diameter	mm	875
Third brush diameter	mm	875
Waste hopper capacity	L	3300
Dumping height	mm	1600
Water tank capacity	L	380
Seats in the cabin	n°	2
Cleaning performance	m ² /h	87000
Maximum speed	Km/h	40
Filtration PM10	%	99
Engine "Make"		VM
Alimentation		Diesel
Weight	Kg	4585

DULEVO INTERNATIONAL S.P.A.

Via G.Guareschi,1 - 43012 - Fontanellato (Parma) Italia

ph: +39 0521 827711 - Fax: +39 0521 827795

info@dulevo.com - www.dulevo.com

